

Panasonic®

Basic Operating Instructions

Digital Camera

Model No. **DMC-TZ60**
DMC-TZ61

LUMIX



Please read these instructions carefully before using this product, and save this manual for future use.

More detailed instructions on the operation of this camera are contained in "Operating Instructions for advanced features (PDF format)" in the supplied CD-ROM. Install it on your PC to read it.



Web Site: <http://www.panasonic.com>

Model number suffix "EB" denotes UK model.

EB

VQT5E64
M0114KZ0

Dear Customer,

We would like to take this opportunity to thank you for purchasing this Panasonic Digital Camera. Please read these Operating Instructions carefully and keep them handy for future reference. Please note that the actual controls and components, menu items, etc. of your Digital Camera may look somewhat different from those shown in the illustrations in these Operating Instructions.

Carefully observe copyright laws.

- Recording of pre-recorded tapes or discs or other published or broadcast material for purposes other than your own private use may infringe copyright laws. Even for the purpose of private use, recording of certain material may be restricted.

Information for Your Safety

WARNING:

To reduce the risk of fire, electric shock or product damage,

- **Do not expose this unit to rain, moisture, dripping or splashing.**
- **Use only the recommended accessories.**
- **Do not remove covers.**
- **Do not repair this unit by yourself. Refer servicing to qualified service personnel.**

The socket outlet shall be installed near the equipment and shall be easily accessible.

■ Product identification marking

Product	Location
Digital camera	Bottom

■ About the battery pack

CAUTION

- Danger of explosion if battery is incorrectly replaced. Replace only with the type recommended by the manufacturer.
 - When disposing the batteries, please contact your local authorities or dealer and ask for the correct method of disposal.
-
- Do not heat or expose to flame.
 - Do not leave the battery(ies) in a car exposed to direct sunlight for a long period of time with doors and windows closed.

Warning

Risk of fire, explosion and burns. Do not disassemble, heat above 60 °C or incinerate.

■ About the AC adaptor (supplied)

CAUTION!

To reduce the risk of fire, electric shock or product damage,

- **Do not install or place this unit in a bookcase, built-in cabinet or in another confined space. Ensure this unit is well ventilated.**
-
- The unit is in the standby condition when the AC adaptor is connected. The primary circuit is always "live" as long as the AC adaptor is connected to an electrical outlet.

■ Cautions for Use

- Do not use any other USB connection cables except the supplied one or a genuine Panasonic USB connection cable (DMW-USBC1: optional).
- Always use a genuine Panasonic AV cable (DMW-AVC1: optional).
- Use a “High Speed HDMI micro cable” with the HDMI logo. Cables that do not comply with the HDMI standards will not work.
“High Speed HDMI micro cable” (Type D-Type A plug, up to 2 m (6.6 feet) long)

Keep this unit as far away as possible from electromagnetic equipment (such as microwave ovens, TVs, video games etc.).

- If you use this unit on top of or near a TV, the pictures and/or sound on this unit may be disrupted by electromagnetic wave radiation.
- Do not use this unit near cell phones because doing so may result in noise adversely affecting the pictures and/or sound.
- Recorded data may be damaged, or pictures may be distorted, by strong magnetic fields created by speakers or large motors.
- Electromagnetic wave radiation may adversely affect this unit, disturbing the pictures and/or sound.
- If this unit is adversely affected by electromagnetic equipment and stops functioning properly, turn this unit off and remove the battery or disconnect AC adaptor (supplied). Then reinsert the battery or reconnect AC adaptor and turn this unit on.

Do not use this unit near radio transmitters or high-voltage lines.

- If you record near radio transmitters or high-voltage lines, the recorded pictures and/or sound may be adversely affected.

CE 1731

Declaration of Conformity (DoC)

Hereby, "*Panasonic Corporation*" declares that this product is in compliance with the essential requirements and other relevant provisions of Directive 1999/5/EC.

Customers can download a copy of the original DoC to our R&TTE products from our DoC server:

<http://www.doc.panasonic.de>

Contact to Authorized Representative:

Panasonic Marketing Europe GmbH, Panasonic Testing Centre,
Winsbergring 15, 22525 Hamburg, Germany

This product is intended for general consumer. (Category 3)

This product on purpose to connect to access point of 2.4 GHz WLAN.



These symbols indicate separate collection of waste electrical and electronic equipment or waste batteries.

More detailed information is contained in "Operating Instructions for advanced features (PDF format)".

Contents

Information for Your Safety	2	Registering preferred	
Before use	7	functions to the	
Standard accessories	8	[Fn] button.....	26
Names and Functions of		Taking pictures with the	
Main Parts	10	composition determined	
Inserting and removing the		[Composition Guide]	26
battery or SD memory card		Viewing your pictures	27
(optional)	13	Deleting pictures	27
Charging the battery	14	What you can do with the	
Setting the clock.....	16	Wi-Fi® function.....	28
Setting the menu	18	GPS functions.....	30
Taking pictures with		Reading the Operating	
automatic settings		Instructions (PDF format)	31
[Intelligent Auto] Mode.....	19	Supplied software.....	32
Recording motion pictures... 	22	Copying still pictures and	
Using the control ring/		motion pictures.....	33
control dial	24	Troubleshooting	34
		Specifications	36

Before use

■ Camera handling

- Keep the camera away from excessive vibration, force, or pressure.
- The camera is not dust resistant, splash resistant, or waterproof. Avoid using the camera in places with excessive dust or sand, or where water can come into contact with the camera.
- Do not allow camera to come into contact with pesticides or volatile substances (can cause surface damage or coating to peel).

■ Condensation (When the lens, the LCD monitor or the viewfinder is fogged up)





- Condensation may occur when the camera is exposed to sudden changes of temperature or humidity. Avoid these conditions, which may make the lens, the LCD monitor or the viewfinder dirty, cause mould, or damage the camera.
- If condensation does occur, turn off the camera and wait about two hours before using it. Once the camera adjusts to the surrounding temperature, the fogging will clear naturally.

■ Caring for your camera

- Before cleaning the camera, remove the battery or disconnect the power plug from the outlet.
- Do not press the LCD monitor with excessive force.
- Do not press the lens with excessive force.
- Do not keep rubber or plastic products in contact with the camera for a long period of time.
- Do not use solvents such as benzene, thinner, alcohol, kitchen detergents, etc., to clean the camera, since it may deteriorate the external case or the coating may peel off.
- Do not leave the camera with the lens facing the sun, as rays of light from the sun may cause it to malfunction.
- Do not extend the supplied cord or cable.
- While the camera is accessing the card or built-in memory (for an operation such as picture writing, reading, deleting, or formatting), do not turn off the camera or remove the battery, card, AC adaptor (supplied).
- The data on the built-in memory or the card may be damaged or lost due to electromagnetic waves, static electricity or breakdown of the camera or the card. We recommend storing important data on a PC etc.
- Do not format the card on your PC or other equipment. Format it on the camera only to ensure proper operation.

Standard accessories

Check that all the accessories are supplied before using the camera. Part numbers are as of January 2014. These may be subject to change.

<input type="checkbox"/> Battery pack DMW-BCM13E • Charge the battery before use. Battery pack is indicated as battery pack or battery in the text. 	<input type="checkbox"/> USB connection cable K1HY08YY0031 
<input type="checkbox"/> AC adaptor VSK0775 	<input type="checkbox"/> CD-ROM VFF1256 • Software: Use it to install the software on your PC. • Operating Instructions for advanced features 
<input type="checkbox"/> Hand strap VFC4297 	

- SD Memory Card, SDHC Memory Card and SDXC Memory Card are indicated as card in the text.
- **Cards are optional.** You can record or play back pictures on the built-in memory when you are not using a card.
- **Compatible memory cards (optional)**
The following SD standard-based cards (Panasonic brand recommended) can be used.
SD Memory Card (8 MB to 2 GB) / SDHC Memory Card (4 GB to 32 GB) / SDXC Memory Card (48 GB, 64 GB)
- Consult the dealer or your nearest Service Centre if you lose the supplied accessories. (You can purchase the accessories separately.)
- Please dispose of all packaging appropriately.
- Keep small parts in a safe place out of the reach of children.
- The illustrations and screens in this manual may differ from the actual product.
- SILKYPIX Developer Studio SE is not provided on the supplied CD-ROM. Download this software from the website and install it on your computer to use. (→33)

■ Optional Accessories

Battery pack	DMW-BCM13
USB connection cable	DMW-USBC1
AV cable	DMW-AVC1

- Some optional accessories may not be available in some countries.

Sales and Support Information

Customer Communications Centre

- For customers within the U.K.: 0844 844 3899
- For customers within Ireland: 01289 8333
- Monday - Friday 9:00am - 5:00pm (Excluding public holidays).
- For further support on your product, please visit our website:
www.panasonic.co.uk

Direct Sales at Panasonic U.K.

- Order accessory and consumable items for your product with ease and confidence by phoning our Customer Communications Centre Monday - Friday 9:00am - 5:00pm (Excluding public holidays).
- Or go on line through our Internet Accessory ordering application at www.pas-europe.com.
- Most major credit and debit cards accepted.
- All enquiries transactions and distribution facilities are provided directly by Panasonic U.K.
- It couldn't be simpler!
- Also available through our Internet is direct shopping for a wide range of finished products. Take a browse on our website for further details.

Names and Functions of Main Parts

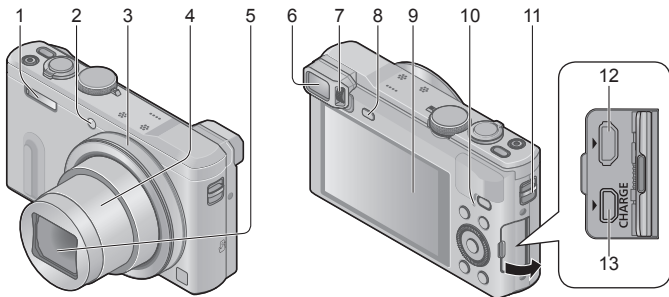

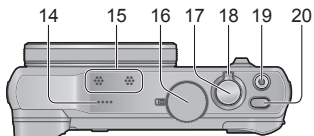

(Top)

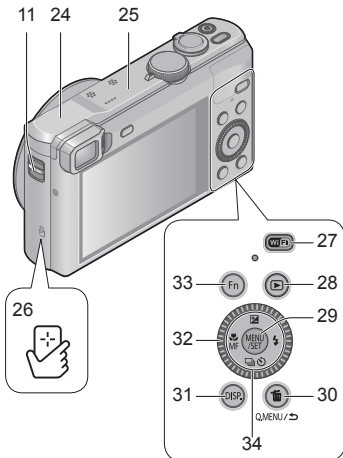
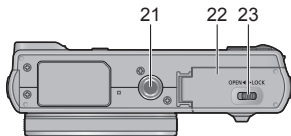

(Bottom)



- 1 Flash
- 2 Self-timer indicator/
AF Assist Lamp
- 3 Control ring
- 4 Lens barrel
- 5 Lens
 - Do not touch the lens barrier.
- 6 Viewfinder (LVF)
- 7 Diopter adjustment dial
 - Adjusts the focus in the viewfinder.
- 8 [LVF] button
 - Use this to switch display between viewfinder and LCD monitor.
- 9 LCD Monitor
- 10 Charging lamp (Red)/
Wi-Fi® connection lamp (Blue)/
GPS status indicator (Green)
 - The colour of the lamp differs depending on the function.
- 11 Strap eyelet
 - We recommend using the supplied hand strap to avoid dropping the camera.
- 12 [HDMI] socket
 - Do not connect any other cables except the HDMI micro cable. Doing so may cause malfunction.
- 13 [AV OUT/DIGITAL] socket
 - This socket is also used when charging the battery.
- 14 Speaker
- 15 Microphones
- 16 Mode dial
 - Use this to select the recording mode.
- 17 Shutter button
- 18 Zoom lever
- 19 Motion picture button
- 20 Camera [ON/OFF] button
- 21 Tripod mount
 - Do not attach to a tripod with a 5.5 mm (0.22 inch) or longer screw. Doing so may damage this unit.
 - If you are not holding the camera, for example when using self-timer recording or remote recording, the camera could tilt when the lens barrel extends during zooming, so make sure to secure the camera in place with a tripod or by other means.
 - It may not be possible to attach certain types of tripods properly.
- 22 Card/Battery door
- 23 Release lever
- 24 [Wi-Fi] antenna
- 25 GPS antenna
- 26 NFC antenna
- 27 [Wi-Fi] button
- 28 Playback button
 - Use this to select the recording mode or playback mode.
- 29 [MENU/SET] button
- 30 [Q.MENU/  / ] button
 - You can display the Quick Menu and erase pictures.
- 31 [DISP.] button
 - Use this to change display.
- 32 Control dial
 - Turn the dial to select setting items and change setting values.
- 33 [Fn] button
- 34 Cursor button

[MENU/SET] button / Cursor button

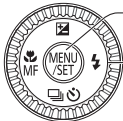

[MENU/SET] button

- Use this button to display the menus, enter the settings, etc.

Cursor button

- This button is used to move the cursor on the menu screens and for other functions.
- In this manual, the button that is to be used is indicated by ▲▼◀▶.

You can perform the following operations while recording.

[] button (▲)

- Exposure Compensation
 - Corrects the exposure when there is a backlight or when the subject is too dark or too bright.

[] button (▶)

- Flash

[] button (▼)

- Burst*
 - A burst of still pictures can be recorded while the shutter button is pressed fully.
- Auto Bracket*
 - Records 3 pictures in continuous succession while exposure is changed automatically. After exposure adjustment, the adjustment value is set as the standard.
- Self-timer*
 - This is effective for preventing jitter when pressing the shutter button, by setting the self-timer to 2 seconds.

*To cancel the setting, select [] or [].

[] button (◀)

- Macro recording
 - When you want to enlarge the subject, setting to [AF Macro] ([]) enables you to take pictures at an even closer distance than the normal focus range (up to 3 cm (0.098 feet) for max. Wide).
- Manual Focus
 - Manual Focus is convenient when you want to lock the focus to take pictures or when it is difficult to adjust focus using Auto Focus.

Inserting and removing the battery or SD memory card (optional)

Make sure that the camera is turned off.

- 1 Slide the release lever (A) to the [OPEN] position and open the card/battery door**



- 2 Insert the battery and card, making sure that their orientation is correct**

- Battery: Insert the battery all the way firmly and check that it is locked by lever (B).
- Card: Insert the card all the way firmly until it clicks. Do not touch the terminals on the back of the card.

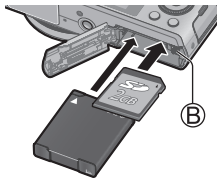

- 3 Close the door**

Slide the release lever to the [LOCK] position.

■ To remove

• To remove battery:

Move lever in direction of arrow.

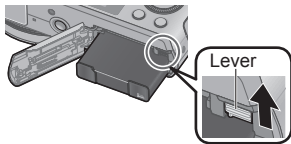

• To remove card:

Push the card until it clicks, then pull the card out.

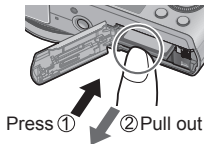

- Always use genuine Panasonic batteries (DMW-BCM13E).
- If you use other batteries, we cannot guarantee the quality of this product.
- Keep the Memory Card out of reach of children to prevent swallowing.
- We recommend using a Panasonic card.

Charging the battery

- The battery that can be used with this unit is DMW-BCM13E.
- The battery is not charged when the camera is shipped. Charge the battery before use.

Make sure that the camera is turned off.

1 Insert the battery to this unit, and then connect this unit to the AC adaptor (supplied) (A) or a PC (B)

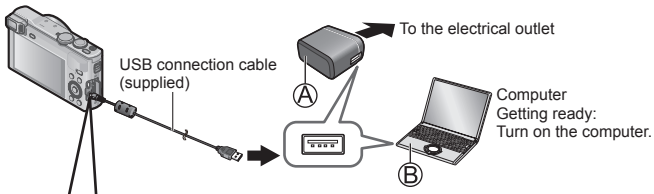

When charging the camera, connect the USB connection cable (supplied) to the [AV OUT/DIGITAL] socket (gold terminal). Connecting the cable to a wrong terminal may cause malfunction.

[AV OUT/DIGITAL] socket

- Place the camera in an upright position, and find the gold terminal at the bottom.

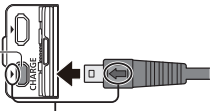

- Insert the USB connection cable so that its [←] mark will face the [▶] mark side of the camera.
- Always check the direction of the pins and hold the plug straight to insert or remove it. (If the cable is inserted in the wrong direction, the pins could become deformed and cause faulty operation.) Also, do not insert into the wrong socket. Doing so may cause damage to this unit.



■ **Charging lamp (Red)**

On: Charging in progress

Off: Charging stops

(After charging stops, disconnect the camera from the electrical outlet or your computer.)

Flashing: Charging error

(For instructions on correcting the problem, refer to "Troubleshooting" (→34).)

■ **Notes on charging time**

When using the AC adaptor (supplied)

Charging time	Approx. 170 min
----------------------	-----------------

- The battery is a rechargeable lithium ion battery. If the temperature is too high or too low, the operating time of the battery will become shorter.
- The battery becomes warm after using and during and after charging. The camera also becomes warm during use. This is not a malfunction.
- Do not peel off or scratch the covering on the battery.
- **Do not leave any metal items (such as clips) near the contact areas of the power plug or near the batteries.**
- Store the battery in a cool and dry place with a relatively stable temperature. (Recommended temperature: 15 °C to 25 °C (59 °F to 77 °F), Recommended humidity: 40%RH to 60%RH)
- **Do not store the battery for a long time while fully charged.** When storing the battery for a long period of time, we recommend charging it once a year. Remove the battery from the camera and store it again after it has completely discharged.
- If you try to recharge the battery when it is already fully charged, the charging lamp will light for approximately 15 seconds.

When using the AC adaptor (supplied), observe the following points as improper connections may cause malfunctions.

- Do not use any other USB connection cables except the supplied one or a genuine Panasonic USB connection cable (DMW-USBC1: optional).
- Do not use any other AC adaptors except the supplied one.
- Do not use the AC adaptor (supplied) or the USB connection cable (supplied) with other devices.

Setting the clock

The clock is not set when the camera is shipped.
Disconnect the unit from the AC adaptor (supplied).

- 1 Press the Camera [ON/OFF] button (A)**
- 2 Press [MENU/SET] (B)**
- 3 Press ◀▶ to select the items (year, month, day, hour, minute, display order or time display format), and press ▲▼ to set**
 - To cancel → Press [Q.MENU/↶] button.
- 4 Press [MENU/SET] to set**
- 5 Confirm the setting and press [MENU/SET]**
 - To return to the previous screen, press [Q.MENU/↶] button.
- 6 Press ◀ to select [Yes] and press [MENU/SET] if automatically correcting time of day using the GPS function**
 - [GPS Setting] is set to [ON]
 - To manually set date and time → Select [No], and press [MENU/SET].
- 7 When [Please set the home area] is displayed, press [MENU/SET]**

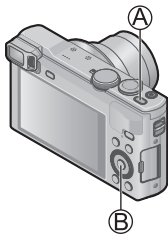

(Continued on the next page)

8 Press ◀▶ to set your home area and press [MENU/SET]

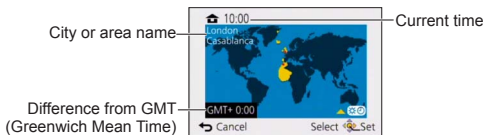

- If the time zone of your current location is different from that of [Home], [World Time] is set to [Destination]. ([✈️]) will be displayed next to the time and date on the screen)

■ Changing time settings

Select [Clock Set] from [Setup] menu, perform 3 and 4.
Please see the next page on how to set the menu.

Setting the menu

Refer to the following procedures to operate the menus.

Example: Setting [AF Mode] from [□] to [⦿] in the [Program AE] Mode

1 Press [MENU/SET] to display the menu

2 Press ▲▼◀▶ or turn the control dial to select the [Rec] menu, and press [MENU/SET]



3 Press ▲▼ or turn the control dial to select [AF Mode], and press [MENU/SET]

- Depending on the item, its setting may not appear or it may be displayed in a different way.



4 Press ▲▼ or turn the control dial to select [⦿], and press [MENU/SET]

5 Press [Q.MENU/↵] button several times to close the menu

- In recording mode, the menu screen can also be exited by pressing the shutter button halfway.

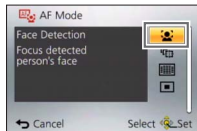

■ Menu types

- [Rec]
- [Motion Picture]
- [GPS]
- [Setup]
- [Wi-Fi]
- [Playback Mode]
- [Playback]

Taking pictures with automatic settings

[Intelligent Auto] Mode

This mode is recommended for those who want to point and shoot or beginners as the camera optimises settings to match the subject and recording environment.

1 Set mode dial to [iA] ([Intelligent Auto] Mode)

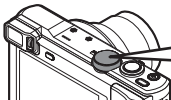

Align the mode dial correctly to the mode that you want to use.

2 Take a picture

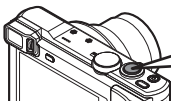











Press halfway
(press lightly to focus)



Press fully
(press the button all the way to record)



■ Automatic Scene Detection

Camera reads scene when pointed at subject, and makes optimum settings automatically.

 [i-Portrait]	 [i-Night Portrait] (Only when [i&A] is selected)
 [i-Baby]	
 [i-Scenery]	 [i-Night Scenery]
 [i-Sunset]	 [i-Handheld Night Shot]
 [i-Macro]	 [i-Food]
 [iA] When scene does not correspond to any of the above	

Taking pictures with automatic settings [Intelligent Auto] Mode

■ Recording modes

iA	[Intelligent Auto] Mode Take pictures with automatic settings. iA+ You can switch to the [Intelligent Auto Plus] Mode on the menu to adjust the brightness and colour settings to your liking.
P	[Program AE] Mode Take pictures with automatic shutter speed and aperture value settings.
A	[Aperture-Priority] Mode Determine aperture, then record pictures.
S	[Shutter-Priority] Mode Determine shutter speed, then record pictures.
M	[Manual Exposure] Mode Determine aperture and shutter speed, then record pictures.
C1 C2	[Custom] Mode Record pictures using pre-registered settings.
	[Panorama Shot] Mode Record panorama pictures.
SCN	[Scene Mode] This allows you to take pictures that match the scene being recorded.
	[Creative Control] Mode Take pictures by selecting your preferred picture effect.

■ Holding the camera

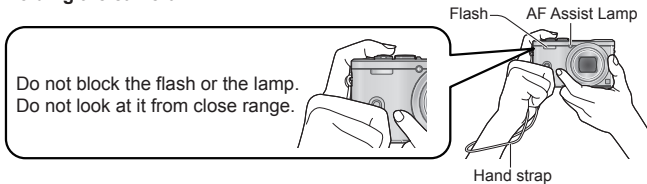

- To avoid camera shake, hold it with both hands keeping your arms close to your body while standing with your feet slightly apart.
- Do not touch the lens.

■ Zoom types

You can adjust the area of a picture to be taken using zoom.

Capture a wider area  Enlarge the subject
(wide-angle) (telephoto)

• Optical Zoom

Zooming in up to 30x is possible if pictures without **[E2]** have been selected by [Picture Size] on the [Rec] menu.

• Extra optical zoom

Zooming in up to 71.7x is possible when pictures with **[E2]** have been selected by [Picture Size] on the [Rec] menu.

• [i.Zoom]

Increase the zoom ratio up to 2x higher than the original zoom ratio with limited deterioration of picture quality. Set the [i.Zoom] in the [Rec] menu to [ON].

• [Digital Zoom]

Zoom 4x further than Optical/Extra optical zoom. Note that, with Digital Zoom, enlarging will decrease picture quality. Set the [Digital Zoom] in the [Rec] menu to [ON].

• [Step Zoom]

Each time the control ring/control dial is operated, the zoom stops at the position for one of the preset focal lengths.

■ Menu convenient for taking pictures

• [Picture Size]

Recording capacity guidelines (still pictures)

Save location	18M	5M	0.3M
Built-in Memory	1	3	69
Card (2 GB)	270	650	10050

(When [Aspect Ratio] is set to **[4:3]** and [Quality] is set to **[■]**)

Recording motion pictures

You can record motion pictures with audio (stereo).

- You can record motion pictures fitting each recording mode.
- Motion pictures cannot be recorded in the built-in memory.

1 Press the motion picture button (A) to start recording

- Do not block the microphones (B) when recording motion pictures.
- You can also use zoom while recording motion pictures.
 - The zoom speed will be slower than normal.
 - The operating sounds of the zoom lever or control ring/control dial may be recorded in some cases.
- Still pictures can be taken during motion picture recording.

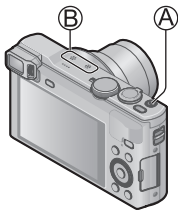

2 Press the motion picture button (A) again to end recording

- About recording time
 - You can continuously record a motion picture in [MP4] for up to 29 minutes 59 seconds or approx. 4 GB. (Since recording in [MP4] with [FHD/25p] creates larger files, the recording time for such motion pictures will be shorter than 29 minutes 59 seconds.)
 - You can continuously record [AVCHD] motion pictures for up to 29 minutes 59 seconds.
- Motion pictures cannot be recorded in the following cases.
 - [Panorama Shot] Mode
 - [3D Photo Mode] ([Scene Mode])
 - [Soft Focus]/[Star Filter] ([Creative Control] Mode)

■ About the recording format for recording motion pictures

This unit can record motion pictures in either AVCHD or MP4 formats.

The recording format for motion pictures can be changed in [Rec Format] of the [Motion Picture] menu.

■ About the recording quality setting

The recording quality for motion pictures can be changed in [Rec Quality] of the [Motion Picture] menu.

[AVCHD] in [Rec Format]

* AVCHD Progressive

Item	Picture size	fps	Bit rate
[FHD/50p]/ G *	1920×1080	50p	Approx. 28 Mbps
[FHD/50p]*			
[FHD/50i]/ G	1920×1080	50i	Approx. 17 Mbps
[FHD/50i]			
[HD/50p]/ G	1280×720	50p	Approx. 17 Mbps
[HD/50p]			

- Select picture quality settings with the [**G**] to record location information and place name information.

[MP4] in [Rec Format]

Item	Picture size	fps	Bit rate
[FHD/25p]	1920×1080	25p	Approx. 20 Mbps
[HD/25p]	1280×720	25p	Approx. 10 Mbps
[VGA/25p]	640×480	25p	Approx. 4 Mbps

■ About motion picture icon

[Rec Format] ———— **AVCHD G** ———— Location information/Place name log
Picture size ———— **FHD|50i** ———— fps

- If the surrounding temperature is high, or a motion picture is recorded continuously, [**△**] is displayed and recording may be stopped halfway through to protect the camera.
- If Extra optical zoom is used before pressing the motion picture button, these settings will be cleared, and the recordable area will be changed significantly.

Using the control ring/control dial

You can use the control ring/control dial to perform frequently used operations and settings directly.

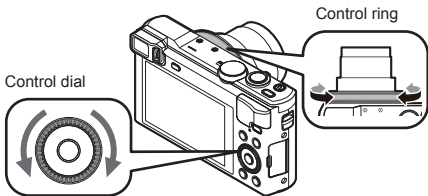

Items that can be set by the control ring/control dial vary depending on recording modes. Following are the pre-assigned settings.

Recording mode	Setting	
	Control ring*1	Control dial
iA	Step Zoom (→21)	
P	Programme Shift	
A	Aperture adjustment	
S	Shutter speed adjustment	
M	Aperture adjustment	Shutter speed adjustment*2
	Picture effects change	
SCN	Scene change	
	Picture effects change	

*1 When Manual Focus is set, the control ring is assigned to focus adjustment.

*2 Press to switch between aperture adjustment and shutter speed adjustment.

■ To change the settings assigned to the control ring/control dial

Changes the settings assigned to the control ring/control dial.

- ① Press [MENU/SET]
- ② Press ▲▼◀▶ to select [Setup] menu and press [MENU/SET]
- ③ Press ▲▼ to select [Ring/Dial Set] and press [MENU/SET]
- ④ Press ▲▼ to select [(0)] (control ring) or [(⦿)] (control dial), and then press [MENU/SET]
- ⑤ Press ▲▼ to select the setting and press [MENU/SET]
The following settings can be assigned
 - [Default Control]
 - [Zoom]
 - [Step Zoom]
 - [Exposure Comp.]
 - [Aspect Ratio]
 - [Sensitivity]
 - [White Balance]
 - [Not Set] (control ring only)
- ⑥ Press [Q.MENU/↵] button several times
 - The assigned function setting applies to all the recording modes. However, the assigned function may not operate when combined with certain recording mode.

■ Using Quick menu

During recording, you can easily call some of the menu items and set them.

- ① Press [Q.MENU/↵] button
- ② Press ◀▶ to select menu items
 - The menu items and setting items that are displayed differ depending on the recording mode.
- ③ Turn the control ring or control dial to change the setting
- ④ Press [MENU/SET]

Registering preferred functions to the [Fn] button

It is set to [Composition Guide] at the time of purchase.

- 1 Press [MENU/SET]
- 2 Press ▲ ▼ ◀ ▶ to select [Setup] menu and press [MENU/SET]
- 3 Press ▲ ▼ to select [Fn Button Set] and press [MENU/SET]
- 4 Press ▲ ▼ to select the function to register and press [MENU/SET]

Taking pictures with the composition determined [Composition Guide]

- 1 Press [Fn] button
 - If the setting of the [Fn] button has been changed, select [Composition Guide] in the [Setup] menu and press [MENU/SET].
- 2 Press ▲ ▼ to select the guideline to display and press [MENU/SET]
 - Explanations and examples of the composition will be displayed in turn when you press the [DISP.] button.

■ Guidelines (Examples) [Rule of Thirds Offset]

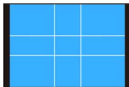

[Diagonal lines]



[Radiation]



Viewing your pictures

1 Press the Playback button (A)

- By holding down the Playback button while the camera is off, you can turn the camera on in playback mode.

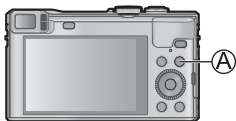

2 Press ◀▶ or turn the control dial to select the picture to be displayed

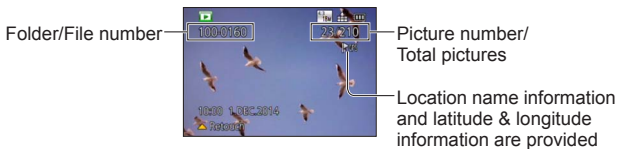

- To play back a motion picture, select a picture with the motion picture icon, and press ▲.

Deleting pictures

Deleted pictures cannot be recovered.

1 Press [🗑️] button (A) to delete the displayed picture

2 Press ◀ to select [Yes] and then press [MENU/SET] (B)

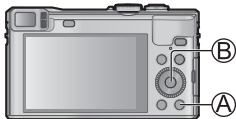

What you can do with the Wi-Fi® function

■ Using a smartphone/tablet as a camera remote control

By installing the “Panasonic Image App” on your smartphone/tablet, you can operate the camera remotely and use the smartphone/tablet to record and play back. In addition, you can copy pictures in the camera to the smartphone/tablet.

- For information on installing “Panasonic Image App” and basic operations on the smartphone/tablet, refer to “Wi-Fi® Quick Guide”.



■ Sending pictures to Wi-Fi compatible equipment

You can select pictures on your camera and transfer them to a TV, printer, AV equipment, PC, etc.



■ Transferring pictures automatically [Smart Transfer]

Transfer recorded images to a PC, an AV device or a Cloud Folder automatically.



■ Using WEB services

Through “LUMIX CLUB”, you can send still pictures and motion pictures to social networking services, etc. To upload recorded pictures to a social networking service right away, we recommend that you first send the pictures to your smartphone/tablet and then upload them from your smartphone/tablet.

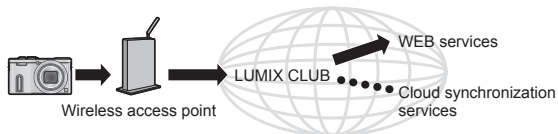

■ LUMIX CLUB

If you register this unit to the “LUMIX CLUB”, you can synchronise images between the devices you are using, or transfer these images to WEB services.

For details, refer to the “LUMIX CLUB” site.

<http://lumixclub.panasonic.net/eng/c/>

Please refer to “Operating Instructions for advanced features (PDF format)” for details.

- When sending images on a mobile network, high packet communication fees may be incurred depending on the details of your contract.
- The camera uses WPA and WPA2 security.
- Hereafter, this manual uses the term “smartphone” for both smartphones and tablets unless it is particularly distinguishing between them.

GPS functions

Before using the camera, be sure to read "User Licence Agreement for Location Name Data" (Operating Instructions for advanced features).

This camera can record the location information of a place where a picture was taken on the pictures. The camera can also automatically adjust the time.

Using the GPS function to execute positioning

- 1 Press [MENU/SET]**
- 2 Press ▲ ▼ ◀ ▶ to select [GPS] menu and press [MENU/SET]**
- 3 Press ▲ ▼ to select [GPS Setting] and press [MENU/SET]**
- 4 Press ▲ ▼ to select [ON] and press [MENU/SET]**
 - A message appears on the screen. After confirming the message, press [MENU/SET].

■ About the GPS function

- Information measured with this unit is simply a rough estimate. Please do not use for professional applications.
- Positioning can be executed faster using GPS assist data.

■ When [GPS Setting] is [ON], the GPS function works even if the camera is turned off

- Electromagnetic waves from the camera can affect instruments and meters. During takeoff and landing of airplanes or in other restricted areas, set [Airplane Mode] to [ON] and turn off the camera.
- When [GPS Setting] is [ON] and [Airplane Mode] is [OFF], power will drain from the battery even if the camera is turned OFF.

■ When using in another country

- The GPS function may not work in China or in the border regions of countries neighbouring China. (Current as of January 2014)
- Some countries or regions may regulate the use of GPS or related technology.

Reading the Operating Instructions (PDF format)

More detailed instructions on the operation of this camera are contained in “Operating Instructions for advanced features (PDF format)” in the supplied CD-ROM. Install it on your PC to read it.

■ For Windows

- 1 Turn the PC on and insert the CD-ROM containing the Operating Instructions (supplied)
- 2 Click the [Operating Instructions]
- 3 Select the desired language and then click [Operating Instructions] to install
Ⓐ To return to the install menu.
- 4 Double-click the “Operating Instructions” shortcut icon on the desktop

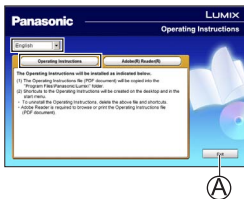

■ When the Operating Instructions (PDF format) will not open

You will need Adobe Acrobat Reader 5.0 or later, or Adobe Reader 7.0 or later to browse or print the Operating Instructions (PDF format).

- You can download and install a version of Adobe Reader that you can use with your OS from the following website.
<http://get.adobe.com/reader/otherversions/>

■ For Mac

- ① Turn the PC on and insert the CD-ROM containing the Operating Instructions (supplied)
- ② Open the “Manual” folder in the CD-ROM and then copy the PDF file with the desired language inside the folder
- ③ Double click the PDF file to open it

Supplied software

The supplied CD-ROM contains the following software.

Install the software on your computer to use.

For details about operating environment and usage, please read “Operating Instructions for advanced features” (PDF format) or the manuals for each software.

- PHOTOfunSTUDIO / LoiLoScope are not compatible with Mac.

PHOTOfunSTUDIO 9.3 PE	Pictures can be captured to a PC, and can be viewed, organised, printed, etc. Also, still pictures can be corrected and motion pictures can be edited. <ul style="list-style-type: none">• Compatible OS: Windows 8.1 / 8 / 7 / Vista / XP
LoiLoScope (30-day full-trial version)	You can edit motion pictures easily. This will only install a shortcut to the trial version download site. For details about using LoiLoScope, please download and see the manual from the following site. http://loilo.tv/product/20/ <ul style="list-style-type: none">• Compatible OS: Windows 8.1 / 8 / 7 / Vista / XP

Installing supplied software

Preparations:

- Check your PC's specifications and operating environment for each software.
- Before inserting the CD-ROM (supplied), close all running applications.

■ For Windows

1 Insert the supplied CD-ROM with the supplied software

2 When the install menu appears, click [Applications]

3 Click [Recommended Installation]

- Continue the installation procedure following the instructions displayed on the screen.
- The software compatible with your PC will be installed.

Downloading SILKYPIX Developer Studio SE

This software develops and edits RAW file pictures. Edited pictures can be saved in a file format such as JPEG or TIFF that can be displayed on a PC, etc. Download SILKYPIX Developer Studio SE from the following site and install it on your computer to use. (This software is not provided on the supplied CD-ROM.)
<http://www.isl.co.jp/SILKYPIX/english/p/>

- Compatible OS: Windows 8.1 / 8 / 7 / Vista / XP
Mac OS X (10.5 - 10.9)
- For details on how to use the SILKYPIX Developer Studio SE, refer to the “Help” or the Ichikawa Soft Laboratory’s support website.
- To download the software, the PC must be connected to the Internet.
- It may take time to download the software in some communication environments.

Copying still pictures and motion pictures

1 Turn on the camera and the PC, and connect them using the USB connection cable (supplied)

- Do not use any other USB connection cables except the supplied one or a genuine Panasonic USB connection cable (DMW-USBC1: optional). Using cables other than the above may cause a malfunction.

2 Press ▲ ▼ on the camera to select [PC], and press [MENU/SET]

3 Copy pictures to your computer

- For Windows
Use “PHOTOfunSTUDIO”.
- For Mac
Copy the picture files contained in the “DCIM” folder (except for AVCHD motion pictures).

4 Cancel the connection and disconnect the USB connection cable

Troubleshooting

First, try out the following procedures.

If the problem persists, performing [Reset] in the [Setup] menu may resolve the issue.

The charging lamp blinks.

- Charging is being performed in a place with extremely high or low temperature.
→ **Reconnect the USB connection cable (supplied) and retry charging in a place where ambient temperature is 10 °C to 30 °C (50 °F to 86 °F) (temperature conditions also apply to the battery itself).**
- Charging is not possible if the power supply capacity of the computer is low.

The lower right portion of recorded pictures appears dark or the colour is unnatural.

- Your finger is blocking the flash.
→ Make sure you are holding the camera correctly. (→20)

Striping or flicker may appear under lighting such as fluorescent lighting and LED lighting fixture.

- This is characteristic of MOS sensors which serve as the camera's pickup sensors. This is not a malfunction.

I would like to upload recorded pictures to a social networking service right after taking them. How can I do that?

- We recommend sending the pictures to your smartphone and uploading them from the smartphone.

I am having a problem connecting to my Windows 8 PC. The user name and password are not recognised.

- Depending on the OS version, on Windows 8, for example, there are two types of user account (local account/Microsoft account). Be sure to use the user name and password for the local account. If you haven't set up a local account, please create one.

The Wi-Fi connection is not recognising my PC.

- By default, the Wi-Fi connection uses the default workgroup name of "WORKGROUP". If the name of the workgroup has been changed, it will not be recognised. Select [PC Connection] then [Change Workgroup Name] in the [Wi-Fi Setup] menu to change the workgroup name to match that of your PC.



The GPS status indicator lights up while the camera is turned off.

- [GPS Setting] is [ON].
- Electromagnetic waves from the camera can affect instruments and meters. In airplane cabins (during takeoff and landing) or in other restricted areas, set [Airplane Mode] to [ON], and then turn off the camera.

Positioning takes time.

- When using the camera for the first time or after not using it for a while, positioning may take several minutes.
- Positioning usually takes less than two minutes, but because the positions of the GPS satellites change, it may take longer depending on the recording location and environment.
- Positioning can be executed faster when you download GPS assist data to the camera using the "GPS Assist Tool".
- Positioning will take time in environments where it is difficult to receive the signals from the GPS satellites.

The location name information is different from the recording location.

- Immediately after the camera is turned on or when the GPS icon is something other than , the location name information that is recorded in the camera may vary significantly from the current position.
- When  is displayed for the location name information, the information can be changed to a different candidate before starting to record. You can edit a place name or landmark name recorded in a picture.

Please refer to "Operating Instructions for advanced features (PDF format)" for details.

Specifications

Digital Camera: Information for your safety

Power Source	DC 5 V
Power Consumption	1.7 W (When recording with LCD Monitor) 1.1 W (When playing back with LCD Monitor)
Camera effective pixels	18,100,000 pixels
Image sensor	1/2.3" MOS sensor, total pixel number 18,900,000 pixels Primary colour filter
Lens	Optical 30x zoom f=4.3 mm to 129.0 mm (35 mm film camera equivalent: 24 mm to 720 mm) / Max. Wide: F3.3 to F8.0 Max. Tele: F6.4 to F8.0
Image Stabiliser	Optical method
Focus range	
AF	50 cm (1.6 feet) (Max. Wide) / 200 cm (6.6 feet) (Max. Tele) to ∞
AF Macro / Intelligent Auto / Motion picture / MF	3 cm (0.098 feet) (Max. Wide) / 200 cm (6.6 feet) (Max. Tele) to ∞
Scene Mode	The focus ranges listed above may vary depending on the selected Scene Mode.
Shutter system	Electronic shutter + Mechanical shutter
Shutter speed	4 seconds to 1/2000th of a second [Starry Sky] Mode: 15 seconds, 30 seconds
Minimum Illumination	Approx. 10 lx (when i-Low light is used, the shutter speed is 1/25th of a second)

Exposure (AE)	Programme AE (P) / Aperture-priority AE (A) / Shutter-priority AE (S) / Manual exposure (M)
Metering Mode	[Multi Metering] / [Center Weighted] / [Spot]
LCD monitor	3.0" TFT LCD (3:2) (Approx. 921,600 dots)
Viewfinder	Colour LCD Viewfinder (Approx. 200,000 dots) (with diopter adjustment -4 to +4 diopter)
Microphones	Stereo
Speaker	Monaural
Recording media	Built-in Memory (Approx. 12 MB) SD Memory Card / SDHC Memory Card / SDXC Memory Card
Recording file format	
Still picture	RAW / JPEG (based on Design rule for Camera File system, based on Exif 2.3 standard / DPOF corresponding) / MPO
Motion pictures	AVCHD / MP4
Audio compression format	AVCHD: Dolby® Digital (2 ch) MP4: AAC (2 ch)
Interface	
Digital	USB 2.0 (High Speed) Data from the PC can not be written to the camera using the USB connection cable.
Analogue video	NTSC / PAL Composite (Switched by menu)
Audio	Audio line output (Monaural)
Terminal	HDMI: MicroHDMI Type D AV OUT/DIGITAL: Dedicated jack (8 pin)
Dimensions	Approx. 110.6 mm (W) x 64.3 mm (H) x 34.4 mm (D) [4.35" (W) x 2.53" (H) x 1.35" (D)] (excluding the projection part)

Specifications

Mass	With card and battery: Approx. 240 g (0.529 lb) Excluding card and battery: Approx. 214 g (0.472 lb)
Operating temperature	0 °C to 40 °C (32 °F to 104 °F)
Operating humidity	10%RH to 80%RH

Wi-Fi

Compliance standard	IEEE 802.11b/g/n (standard wireless LAN protocol)
Frequency range used (central frequency)	2412 MHz to 2462 MHz (1ch to 11ch)
Encryption method	Wi-Fi compliant WPA™ / WPA2™
Access method	Infrastructure mode

NFC

Compliance standard	ISO / IEC 18092 NFC-F (Passive Mode)
----------------------------	--------------------------------------

AC adaptor

(Panasonic VSK0775): Information for your safety

Input	~ 110 V to 240 V, 50/60 Hz, 0.2 A
Output	— 5 V, 800 mA

Battery pack (lithium-ion)

(Panasonic DMW-BCM13E): Information for your safety

Voltage / capacity	3.6 V / 1250 mAh
---------------------------	------------------

Specifications are subject to change without notice.

- SDXC Logo is a trademark of SD-3C, LLC.
- HDMI, the HDMI Logo, and High-Definition Multimedia Interface are trademarks or registered trademarks of HDMI Licensing LLC in the United States and other countries.
- HDAVI Control™ is a trademark of Panasonic Corporation.
- “AVCHD”, “AVCHD Progressive” and the “AVCHD Progressive” logo are trademarks of Panasonic Corporation and Sony Corporation.
- Manufactured under license from Dolby Laboratories. Dolby and the double-D symbol are trademarks of Dolby Laboratories.
- Windows and Windows Vista are either registered trademarks or trademarks of Microsoft Corporation in the United States and/or other countries.
- Mac and Mac OS are trademarks of Apple Inc., registered in the U.S. and other countries.
- QuickTime and the QuickTime logo are trademarks or registered trademarks of Apple Inc., used under license therefrom.
- The Wi-Fi CERTIFIED Logo is a certification mark of the Wi-Fi Alliance.
- The Wi-Fi Protected Setup Mark is a mark of the Wi-Fi Alliance.
- “Wi-Fi”, “Wi-Fi Protected Setup”, “Wi-Fi Direct”, “WPA” and “WPA2” are marks or registered marks of the Wi-Fi Alliance.
- DLNA, the DLNA Logo and DLNA CERTIFIED are trademarks, service marks, or certification marks of the Digital Living Network Alliance.
- This product uses “DynaFont” from DynaComware Corporation. DynaFont is a registered trademark of DynaComware Taiwan Inc.
- Other names, company names, and product names mentioned in these instructions are trademarks or registered trademarks of the companies concerned.



Manufactured by: Panasonic Corporation
Kadoma, Osaka, Japan
Importer for Europe: Panasonic Marketing Europe GmbH
Panasonic Testing Centre
Winsbergring 15, 22525 Hamburg, Germany



Panasonic Corporation
Web Site: <http://panasonic.net>

© Panasonic Corporation 2014